



## WHEELS, SPROCKETS & ROTORS

---

Make a definitive style statement with a set of custom wheels. Whether you're going for an old-school or new-school look, this is where you set the tone. You'll ride comfortably knowing that Harley-Davidson® wheels meet the highest standards of performance and durability.

## STRENGTH AND STYLE

From a visual perspective, the wheels, sprocket and brake rotors make up almost half of the motorcycle's profile, and set the styling direction for the whole bike. Choose wisely. Harley-Davidson® forged, cast and laced wheels undergo thousands of hours of real-world testing to meet the highest standards of performance and durability.



### SEEING THE DIFFERENCE



#### MIRROR CHROME

Looking for the ultimate flash? Choose Mirror Chrome wheels. To achieve this rich look, our dedicated team of polishers spends hours preparing the wheel for its finish. All visible wheel surfaces are micro-polished to a glass smooth finish, and special masking is applied to prevent contamination to threads and bearing bores.



#### CONTRAST CHROME

Can't make up your mind? Choose Contrast Chrome wheels. We start with a hand polished wheel, and add a proprietary finish that features both gloss black paint and chrome highlights. The combination produces a stunning contrast that lightens the wheel's profile by visually thinning the spokes, rim and hub.



#### BLACK ICE

Want the blacked-out look but unwilling to give up the shine? Choose Black Ice wheels. First, we polish all the surfaces. Then we apply the exclusive Black Ice coating for a finish with incredible depth and shimmer—impossible to achieve with ordinary "black chrome." These wheels look perfect on a blacked-out bike, but the wet-look holds its own in the company of chrome.



#### CUT BACK

Looking for a cool, hard-edged style? Choose Cut Back wheels. We start with a raw wheel, polish all the exposed surfaces, and coat the wheel in a durable easy-to-clean gloss black finish. But we don't stop there. We machine an intricate pattern into the wheel to the raw aluminum surface below. The resulting mix of machined edges and add a tough look to your ride's profile.

### WHEEL INSTALLATION KITS

**43833-07A** Front, 3/4" axle. **\$69.95**

Fits '00-'07 XL models, '00-'03 Dyna® models, '00-'05 FXDWG models, '00-'06 Softail® (except FLSTS, FLSTSC and FXSTDSE), and '08-later FLSTSB models.

**43848-08A** Front, 1" axle. **\$69.95**

Fits '02-'07 VRSC™ models, '04-'07 Dyna models (except '04-'05 FXDWG) and '00-'07 Touring models.

**43851-11A** Front, 25mm axle. **\$69.95**

Fits '07-later Softail (except FLSTSB, FLSTSC, FXCW and FXCWC) without ABS and '08-later FLD, FXDF and FXDWG models without ABS brakes.

**41452-08C** Front, 25mm axle. **\$69.95**

Fits '08-later XL models (except '11-later XL883L) and '08-later FXCW and FXCWC models without ABS brakes.

**41454-08B** Front, 25mm axle, ABS. **\$69.95**

Fits '08-later VRSC models with ABS brakes, '12 FXDB, FXDC and FXDL with ABS brakes and '08-later Touring models (except Trike) with ABS brakes.

**41455-08C** Front, 25mm axle. **\$69.95**

Fits '08-later VRSC models without ABS brakes, '08-later Dyna models (except FLD, FXDWG and FXDF) and '08-later Touring and Trike models without ABS brakes. Also fits '09-later Sidecar.

**43093-11A** Front, 25mm axle, ABS. **\$69.95**

Fits '11-later Softail models (except FLSTSB) with ABS brakes and '12 FLD, FXDF and FXDWG models with ABS brakes.

**43854-08A** Rear, 3/4" axle. **\$69.95**

Fits '00-'04 XL models, '00-'05 Dyna models, '00-'07 Softail models, and '00-'01 Touring models.

**43861-08A** Rear, 1" axle. **\$69.95**

Fits '02-'07 VRSC models, '05-'07 XL models, '06-'07 Dyna models, and '02-'07 Touring models.

**43878-08B** Rear, 25mm axle. **\$69.95**

Fits '08-later XL models (except '11-later XL883L), '08-later Softail models without ABS brakes (except FXCW and FXCWC) and '08 Touring models (except Trike) without ABS brakes.

### ORDERING PROCESS

#### CUSTOM WHEEL ORDERING PROCESS

**Step 1:** Select a wheel part number for your specific fitment.

**Step 2:** Select the wheel installation kit for your specific application (model, year, and front or rear). Note: If your model is not specified in the wheel fitment, a wheel installation kit will not make the wheel fit your model.

**Step 3:** Refer to the instruction sheet included in your wheel kit to determine the necessary parts required from the installation kit.

**Step 4:** Use only Harley-Davidson approved tires. Using non-approved tires, tires from different manufacturers, or tires with non-matching tread patterns on the same motorcycle can adversely affect handling and stability.

#### WHEEL INSTALLATION KITS

Once you select your wheel style, select the Wheel Installation Kit designed specifically for your motorcycle. Kit includes the bearings and spacers required for installation.



**41451-08B** Rear, 25mm axle. **\$69.95**

Fits '08-later Dyna models without ABS brakes.

**41456-08C** Rear, 25mm axle. **\$69.95**

Fits '08-later VRSC models without ABS brakes, '08-later FXCW and FXCWC models without ABS brakes and '09-later Touring models (except Trike) without ABS brakes.

**41453-08C** Rear, 25mm axle, ABS. **\$69.95**

Fits '08-later VRSC models with ABS brakes and '08-later Touring models (except Trike) with ABS brakes.

**43077-11** Rear, 25mm axle, ABS. **\$69.95**

Fits '11-later Softail models with ABS brakes.

**42400003** Rear, 25mm axle, ABS. **\$69.95**

Fits '12 Dyna models with ABS brakes.

*Notice: The prices appearing in this catalog are the manufacturer's suggested retail prices. Actual retail prices may vary.*

# 672 WHEELS

Agitator

## A. AGITATOR CUSTOM WHEEL

Get ready to stir things up. The 7 forward-facing spokes of these Agitator Wheels dig deep into the soul for maximum custom impact. Spiraling from the custom hub, the flat profile spokes blend to the edge of the rim, minimizing the profile of the wheel and adding an open look that's easy to see around the matching Floating Brake Rotors. Available in your choice of mirror chrome, contrast chrome or black ice finish, these wheels will set the stage for your custom direction. These cast aluminum wheels have undergone hundreds of hours of real-world testing to meet the highest standards of performance and durability. Requires separate purchase of model-specific Wheel Installation Kit, Sprocket hardware and Brake Rotor-specific hardware. See I-sheet for details. Installation may require separate purchase of wheel size and model-specific tire.

### 19" Front

Fits '09-later Road King®, Road Glide® (except '12 FLTRXSE) and Street Glide® (except Trike) models. Requires separate purchase of Agitator Floating Brake Rotors.

**55071-11** Mirror Chrome. **\$749.95**

Fits '09-later Touring models (except Trike and '12 CVO™ models). Requires separate purchase of Agitator Floating Brake Rotors.

**55070-11** Contrast Chrome. **\$549.95**

**43300115** Black Ice. **\$749.95**

### 18" Front

Fits '09-later Road King and Road Glide models (except '12 FLTRXSE). Requires separate purchase of Floating Brake Rotors.

**47957-10** Mirror Chrome. **\$749.95**

Fits '09-later Touring models (except Trike and '12 CVO models). Requires separate purchase of Floating Brake Rotors.

**40268-10** Contrast Chrome. **\$549.95**

### 18" Rear

Fits '09-later Touring models (except Trike).

**47951-10** Mirror Chrome. **\$749.95**

**40225-10** Contrast Chrome. **\$549.95**

**40900112** Black Ice. **\$749.95**

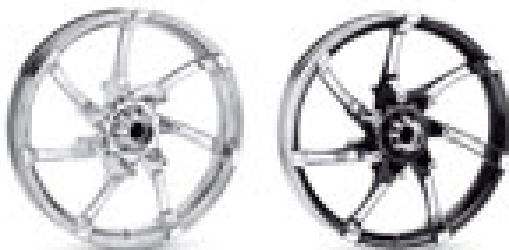

**Mirror Chrome  
Agitator Wheel**

**Contrast Chrome  
Agitator Wheel**



**Black Ice  
Agitator Wheel**

See page 695 for matching Agitator brake rotors.



**A. AGITATOR CUSTOM WHEEL – 19" MIRROR CHROME  
(SHOWN WITH CHROME/RAW AGITATOR FLOATING BRAKE ROTORS)**



**A. AGITATOR CUSTOM WHEEL – 18" CONTRAST CHROME  
(SHOWN WITH RAW/RAW AGITATOR FLOATING BRAKE ROTORS)**

Notice: The prices appearing in this catalog are the manufacturer's suggested retail prices. Actual retail prices may vary.

# WHEELS 673

*Agitator/9-Spoke*

NEW

A

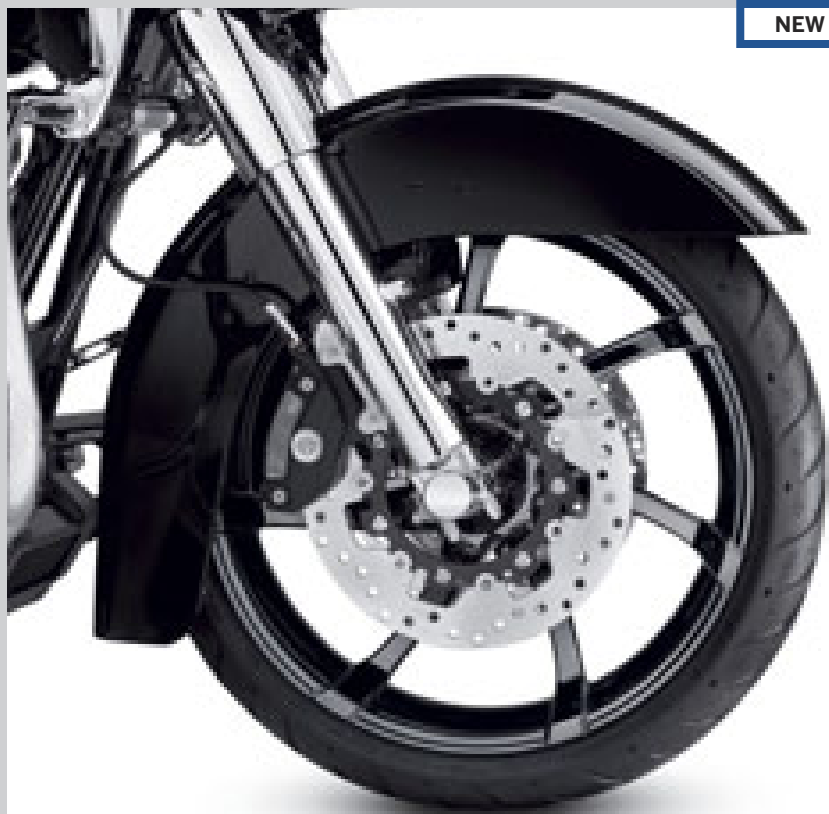

**A. AGITATOR CUSTOM WHEEL – 19" BLACK ICE  
(SHOWN WITH BLACK/POLISHED AGITATOR FLOATING BRAKE ROTORS)**

## B. CHROME 9-SPOKE CAST WHEEL

Add a splash of chrome. These fully polished wheels are styled to match the popular 9-spoke design featured on traditional Touring models. More than just a chrome-plated Original Equipment Touring wheel, these wheels utilize tooling developed specifically for chrome-plating to give a near perfect finish without the "waves" created when polishing the Original Equipment cast wheel. The rib on the Original Equipment wheel spoke has been removed to provide a smooth uninterrupted look, and countless hours of polishing result in a superior finish. Special masking was developed to prevent plating contamination inside bolt holes and bearing bores. All Genuine Motor Accessory wheels have been certified by Harley-Davidson to perform to our tough vehicle standards for quality and durability. Wheel kits require separate purchase of model-specific Wheel Installation Kit, Sprocket hardware and Brake Rotor-specific hardware. See I-sheet for details. Installation may require separate purchase of wheel size and model-specific tire.

### 17" Front

**41886-09 \$549.95**

Fits '09-later Touring models (except Trike and '12 CVO™ models). Also fits '09-'11 Sidecars.

### 16" Front

**41880-07 \$549.95**

Fits '00-later FLST, FLSTC, FLSTN and '00-'06 FLSTF models (except '06 FLSTFSE2).

**41886-07 \$549.95**

Fits '09-later FLHRC models. Also fits '00-'08 Touring models.

### 16" Rear

**41889-09 \$549.95**

Fits '09-later Touring models (except Trike and '12 CVO models).

**41883-07 \$549.95**

Fits '03-'07 FLST, FLSTN, FLSTC, '03-'06 FLSTF (except FLSTFSE2) and '03-'05 FXST, FXSTB and FXSTS models.

**41889-07 \$549.95**

Fits '00-later XL models (except '11-later XL 883L), '00-'05 Dyna® models, '00-'02 Softail® models (except FXSTD) and '00-'08 Touring models.

**40789-08 \$549.95**

Fits '08-later FXS, FLSTN and FLSTC models.

B



**B. CHROME 9-SPOKE CAST WHEEL – 17"  
(SHOWN WITH POLISHED BRAKE ROTORS)**



**Chrome  
9-Spoke Wheel**

See pages 692-695 for custom sprocket and brake rotor options.

Notice: The prices appearing in this catalog are the manufacturer's suggested retail prices. Actual retail prices may vary.

WHEELS

# 674 WHEELS

Roulette

## A. ROULETTE CUSTOM WHEEL

When you take this wheel for a spin, you're always a winner. Stunning cast aluminum wheel features 11 slim spokes that blend with the rim for eye-catching style. The unique spoke shape stands proud on the rim's edge, mimicking the pockets on a roulette wheel. The surface catches and reflects light, just as the raised ridges deflect the spinning roulette ball. Available in your choice of mirror chrome, contrast chrome or black ice finish, these wheels will add a sinister look to your custom ride. These wheels have undergone hundreds of hours of real-world testing to meet the highest standards of performance and durability. Requires separate purchase of model-specific Wheel Installation Kit, sprocket hardware and brake rotor-specific hardware. See I-sheet for details. Installation may require separate purchase of wheel size and model-specific tire.

### 17" Front

Fits '09-later Touring models (except Trike and '12 CVO™ models).

<b>42171-09</b>	Mirror Chrome.	<b>\$749.95</b>
<b>55065-10</b>	Contrast Chrome.	<b>\$599.95</b>
<b>43300116</b>	Black Ice.	<b>\$549.95</b>

### 16" Rear

Fits '09-later Touring models (except Trike and '12 CVO models).

<b>42170-09</b>	Mirror Chrome.	<b>\$749.95</b>
<b>55064-10</b>	Contrast Chrome.	<b>\$599.95</b>
<b>40900113</b>	Black Ice.	<b>\$549.95</b>



**Mirror Chrome  
Roulette Wheel**

**Contrast Chrome  
Roulette Wheel**



**Black Ice  
Roulette Wheel**

See pages 694-695 for matching Teardrop and other custom brake rotor options.



**A. ROULETTE CUSTOM WHEEL – 17" MIRROR CHROME  
(SHOWN WITH CHROME FLOATING BRAKE ROTORS)**



**A. ROULETTE CUSTOM WHEEL – 17" CONTRAST CHROME  
(SHOWN WITH BLACK TEARDROP FLOATING BRAKE ROTORS)**

Notice: The prices appearing in this catalog are the manufacturer's suggested retail prices. Actual retail prices may vary.

# WHEELS 675

Roulette/Airstrike

NEW

A

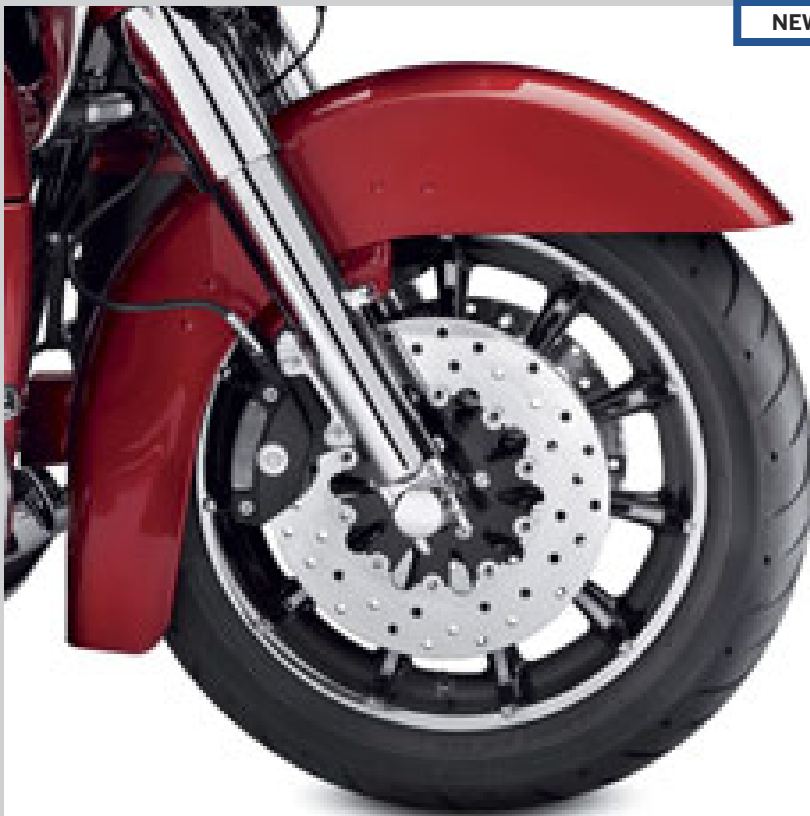

**A. ROULETTE CUSTOM WHEEL – 17" BLACK ICE  
(SHOWN WITH BLACK/POLISHED TEARDROP FLOATING BRAKE ROTORS)**

## B. AIRSTRIKE CUSTOM WHEEL – MIRROR CHROME

Hit your custom target. The wide-open slots and the reflections of the mirror-chromed finish almost make this wheel disappear. Teamed with a low-profile front tire and polished brake rotors, this custom wheel adds visual lightness to the front end of your Touring bike. Extensive polishing, copper buffing and nickel plating prepare the wheel for a layer of brilliant chrome for a beautiful bright finish. All Genuine Motor Accessory wheels have been certified by Harley-Davidson to perform to our tough vehicle standards for quality and durability. Requires separate purchase of model-specific Wheel Installation Kit, sprocket hardware and brake rotor-specific hardware. See I-sheet for details. Installation may require separate purchase of wheel size and model-specific tire.

**55056-10** 18" Front. **\$499.95**  
Fits '08-later Touring models (except Trike and '12 CVO™ models).

**55058-10** 16" Rear. **\$499.95**  
Fits '09-later Touring models (except Trike and '12 CVO models).



**Mirror Chrome  
Airstrike Wheel**

See pages 692-695 for polished and other custom brake rotor options.

B



**B. AIRSTRIKE CUSTOM WHEEL – 18" MIRROR CHROME  
(SHOWN WITH CHROME FLOATING BRAKE ROTORS)**

Notice: The prices appearing in this catalog are the manufacturer's suggested retail prices. Actual retail prices may vary.

# 676 WHEELS

Chisel

## A. CHISEL CUSTOM WHEEL

Honed to a fine edge. These wide-open cast aluminum wheels feature 7 narrow-profile split spokes that radiate from a minimalistic hub. The pedestal-mounted matching floating brake rotors let you see more of the front wheel, and the resulting see-through effect visually lightens the bike's profile to add visual interest. Available in your choice of mirror chrome or contrast chrome finish, these wheels will complement any customizing style. The black and chrome contrast chrome finish was developed by Harley-Davidson to add a sinister look to your custom ride, while the fully-polished mirror chrome option throws flashes of light with every movement. These wheels have undergone hundreds of hours of real-world testing to meet the highest standards of performance and durability. Requires separate purchase of model-specific Wheel Installation Kit, sprocket hardware and brake rotor-specific hardware. See I-sheet for details. Installation may require separate purchase of wheel size and model-specific tire.

### 17" Front

Fits '09-later Touring models (except Trike and '12 CVO™ models). Requires separate purchase of Chisel Floating Brake Rotors.

<b>43300057</b>	Mirror Chrome.	<b>\$749.95</b>
<b>43300059</b>	Contrast Chrome.	<b>\$549.95</b>

### 16" Rear

Fits '09-later Touring models (except Trike and '12 CVO models).

<b>40900067</b>	Mirror Chrome.	<b>\$749.95</b>
<b>40900069</b>	Contrast Chrome.	<b>\$549.95</b>

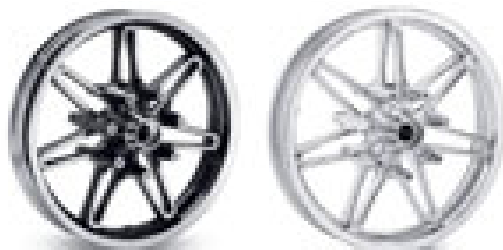

**Contrast Chrome  
Chisel Wheel**

**Mirror Chrome  
Chisel Wheel**

### Shown with:

#### CHISEL FLOATING BRAKE ROTORS

Complete the custom look with Chisel Floating Rotors. Styled to complement the Chisel front wheel, the inner spider features a cutout design that mirrors the wheel's 7 distinctive open spokes. Rotors are available in 2 different finishes to match your customizing direction. Rotors include chrome mounting hardware.

Fits '09-later Touring models (except Trike) equipped with Chisel Custom Front Wheel.

<b>41500040</b>	Polished.	<b>\$159.95</b>
<b>41500042</b>	Raw.	<b>\$139.95</b>



**Polished Rotor**

**Raw Rotor**



**A. CHISEL CUSTOM WHEEL – MIRROR CHROME  
(SHOWN WITH RAW CHISEL FLOATING BRAKE ROTORS)**

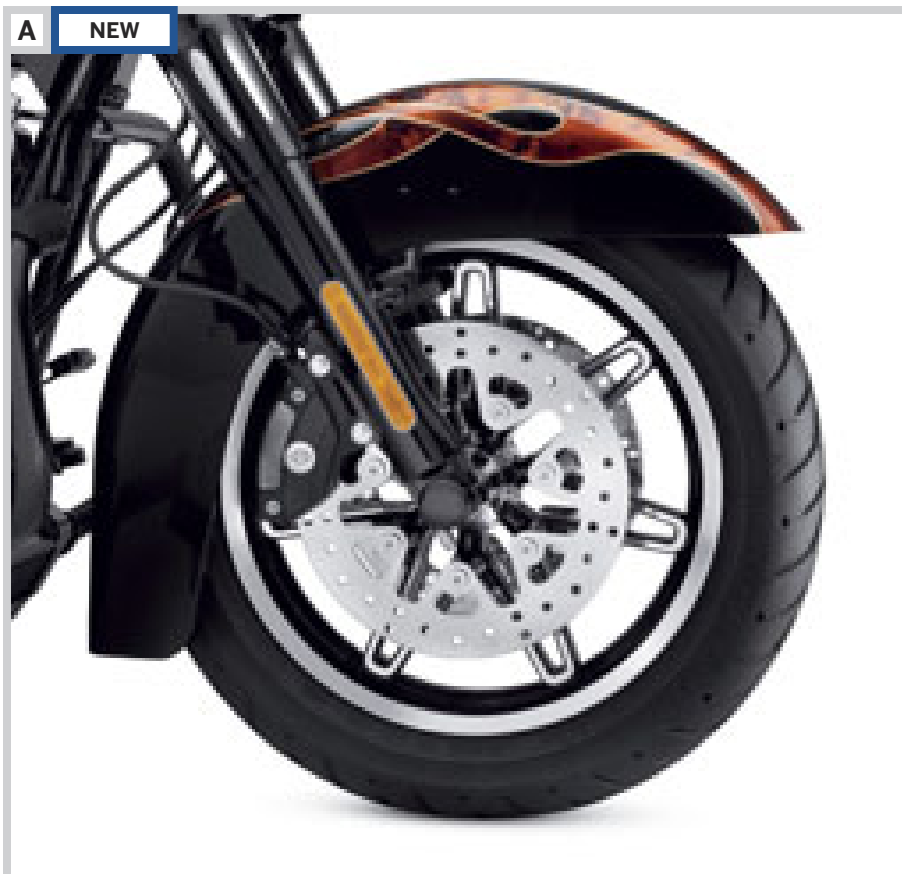

**A. CHISEL CUSTOM WHEEL – CONTRAST CHROME  
(SHOWN WITH POLISHED CHISEL FLOATING BRAKE ROTORS)**

*Notice: The prices appearing in this catalog are the manufacturer's suggested retail prices. Actual retail prices may vary.*

B

## B. ANARCHY 5-SPOKE WHEEL

The 5 beefy spokes of this custom wheel dramatically change the look of your Touring model or Trike. The "ball-milled" spokes radiate from the unique center hub to blend with the machined rim, opening the bike for a light, sporting profile. The smooth curving rim adds to the true custom look. The raised bosses on the chrome hub carry the Floating Brake Rotors, and add to the clean appearance of the installed wheel. Available in your choice of mirror chrome or contrast chrome finish, these wheels add a true hot-rod direction to your ride. The black and chrome contrast chrome finish was developed by Harley-Davidson to add a sinister look to your custom ride, while the fully-polished mirror chrome option throws flashes of light with every movement. These cast aluminum wheels have undergone hundreds of hours of real-world testing to meet the highest standards of performance and durability. Requires separate purchase of model-specific Wheel Installation Kit, sprocket hardware and brake rotor-specific hardware. See I-sheet for details. Installation may require separate purchase of wheel size and model-specific tire. Installation may require separate purchase of wheel size and model-specific tire.

### 18" Front

Fits '09-later Touring (except '12 CVO™) and Trike models. Requires separate purchase of (2) Open Floating Brake Rotors.

<b>55066-11</b>	Mirror Chrome.	<b>\$749.95</b>
<b>55128-11</b>	Contrast Chrome.	<b>\$549.95</b>

### 18" Rear

Fits '09-later Touring models (except Trike and '12 CVO models).

<b>55067-11</b>	Mirror Chrome.	<b>\$749.95</b>
<b>55129-11</b>	Contrast Chrome.	<b>\$549.95</b>

### 16" Rear

Fits '09-later Trike models. Requires separate purchase of 16" Tire and Hub Cap.

<b>55069-11</b>	Mirror Chrome.	<b>\$699.95</b>
<b>55130-11</b>	Contrast Chrome.	<b>\$549.95</b>



**B. ANARCHY 5-SPOKE WHEEL – 18" MIRROR CHROME (SHOWN WITH POLISHED OPEN FLOATING BRAKE ROTORS)**

B



**B. ANARCHY 5-SPOKE WHEEL – 18" CONTRAST CHROME (SHOWN WITH RAW OPEN FLOATING BRAKE ROTORS)**



**Mirror Chrome Anarchy Wheel**

**Contrast Chrome Anarchy Wheel**

### Shown with:

#### OPEN FLOATING BRAKE ROTORS

Complete the custom look with open design Floating Brake Rotors, styled to complement a variety of custom wheels. Rotors are sold individually.

Fits '08-later Touring models with 18" Blade, 18" Road Winder™, 18" Reaper or 18" Anarchy wheels. Fits Trike with 18" Anarchy wheel. Fits '06-later Dyna® models (except FXDF and FXDFSE/2) with stock cast wheels or accessory 19" wheels (except Slotted 6-Spoke 19" front wheel) and fits '06-later VRSC™ models with stock cast wheels or accessory 19" front wheels.

<b>41500012</b>	Polished – Front. Includes installation hardware.	<b>\$139.95</b>
<b>44553-06A</b>	Raw – Front.	<b>\$100.00</b>



**Polished Rotor**

# 678 WHEELS

Knuckles

## A. KNUCKLES 28-SPOKE CUSTOM WHEEL

Add a custom look without changing the distinctive style of your Touring motorcycle. These custom finished versions of the Original Equipment 28-spoke cast aluminum wheels cast glowing reflections, even while standing still. Available in brilliant mirror chrome or a rich contrast black and chrome finish to match your mood, these wheels have undergone hundreds of hours of real-world testing to meet the highest standards of performance and durability. Requires separate purchase of model-specific Wheel Installation Kit, sprocket hardware and brake rotor-specific hardware. See I-sheet for details. Installation may require separate purchase of wheel size and model-specific tire.

### 17" Front

Fits '09-later Touring models (except Trike and '12 CVO™ models).

<b>55060-10</b>	Mirror Chrome.	<b>\$549.95</b>
<b>42195-10</b>	Contrast Chrome.	<b>\$499.95</b>

### 16" Rear

Fits '09-later Touring models (except Trike and '12 CVO models).

<b>55062-10</b>	Mirror Chrome.	<b>\$549.95</b>
<b>42196-10</b>	Contrast Chrome.	<b>\$499.95</b>



Mirror Chrome  
Knuckles Wheel



Contrast Chrome  
Knuckles Wheel

See pages 692-695 for polished and other custom brake rotor options.



A. KNUCKLES 28-SPOKE CUSTOM WHEEL – 17" MIRROR CHROME  
(SHOWN WITH POLISHED BRAKE ROTORS)



A. KNUCKLES 28-SPOKE CUSTOM WHEEL – 17" CONTRAST CHROME  
(SHOWN WITH POLISHED BRAKE ROTORS)

Notice: The prices appearing in this catalog are the manufacturer's suggested retail prices. Actual retail prices may vary.



B

B. BLADE CUSTOM WHEEL – 21" MIRROR CHROME

**B. BLADE CUSTOM WHEEL**

Slash your way to the front of the custom pack. Slick custom wheel design features 10 slim spokes that flow from the center hub and spiral rearward to blend with the outer rim. Forged for strength from 6061 aluminum, these wheels are available in your choice of brilliant mirror chrome or gloss black and machined aluminum Cut Back finish. The forged surfaces resist the elements, and are easy to clean and maintain. All Genuine Motor Accessory wheels have been certified by Harley-Davidson to perform to our tough vehicle standards for quality and durability. Complete the custom look with a complementing Blade Billet Sprocket and Brake Rotors. Requires separate purchase of model-specific Wheel Installation Kit, sprocket hardware and brake rotor-specific hardware. See I-sheet for details. Installation may require separate purchase of wheel size and model-specific tire.

**21" Front**

**41681-07** Mirror Chrome. **\$1,199.95**  
Fits '00-later FXS, FXST, FXSTD (except FXSTDSE), FXSTS, FXSTB, FXSTC and '00-later FXDWG models. Also fits '08 FXDSE2 models.

**18" Front**

Fits '04-later Touring models (except Trike and '12 CVO™ models). Requires separate purchase of Open Brake Rotors. See your Dealer or the instruction sheet for specific part numbers.

**43300008** Mirror Chrome. **\$799.95**  
**43300034** Cut Back Gloss Black. **\$749.95**

**17" Front**

**42191-08** Mirror Chrome. **\$1,199.95**  
Fits '08-later FLSTF and FLSTFB models.

**16" Front**

**40820-08** Mirror Chrome. **\$1,199.95**  
Fits '00-'08 Touring models. Also fits '09-later FLHRC models.

**40822-08** Mirror Chrome. **\$1,199.95**  
Fits '00-later FLST, FLSTC, FLSTN and '00-'06 FLSTF models (except '06 FLSTFSE2).

**18" Rear**

Fits '09-later Touring models (except Trike and '12 CVO models).

**40900009** Mirror Chrome. **\$799.95**  
**40900046** Cut Back Gloss Black. **\$749.95**

**17" Rear**

**40701-08** Mirror Chrome. **\$1,249.95**  
Fits '08-later FXST, FXSTB, FXSTC, FLSTF, FLSTFB and FLSTSB models.

**41567-08** Mirror Chrome. **\$1,249.95**  
Fits '07 FXST, FXSTB, FXSTC and FLSTF models.

**16" Rear**

**40814-08** Mirror Chrome. **\$1,249.95**  
Fits '08-later FXS, FLSTN and FLSTC models.

**40816-08** Mirror Chrome. **\$1,249.95**  
Fits '00-'05 Dyna® models, '00-'02 Softail® (except FXSTD) and '00-'08 Touring models.



NEW

B

B. BLADE CUSTOM WHEEL – 18" CUT BACK GLOSS BLACK (SHOWN WITH POLISHED FLOATING BRAKE ROTORS)

WHEELS



Mirror Chrome Blade Wheel



Cut Back Gloss Black Blade Wheel

See pages 693-694 for matching Blade Rotors and Sprockets.

Notice: The prices appearing in this catalog are the manufacturer's suggested retail prices. Actual retail prices may vary.

# 680 WHEELS

Magnum 5

## A. MAGNUM 5 CUSTOM WHEEL

Click off the safety and pull the trigger for a true custom ride. The bold, brawny design is inspired by the steel of a large-frame revolver. This one-piece cast aluminum wheel features high-impact styling, with 15 individual spokes that converge to form five distinct columns. The cast-in "rivets" visually tie the oval cross-section spokes to the rim and the hub. Finished in your choice of brilliant mirror chrome or gloss black and machined-aluminum Cut Back finish, these wheels hit the styling target like a high-velocity bullet. All Genuine Motor Accessory wheels have been certified by Harley-Davidson to perform to our tough vehicle standards for quality and durability. Requires separate purchase of model-specific Wheel Installation Kit, sprocket hardware and brake rotor-specific hardware. See I-sheet for details. Installation may require separate purchase of wheel size and model-specific tire.

### 21" Front

Fits '00-later FXS, FXST, FXSTD (except FXSTDSE), FXSTB, FXSTC, '00-later FXDWG and '08 FXDSE2 models.

<b>40806-09</b>	Mirror Chrome.	<b>\$549.95</b>
<b>43300051</b>	Cut Back Gloss Black.	<b>\$449.95</b>

### 19" Front

Fits '06-later Dyna® models (except FLD, FXDWG, FXDF and FXDFSE/2). Installation on models equipped with Original Equipment laced wheel will require separate purchase of Floating Brake Rotor. Does not fit with chrome Front Wheel Spacer Kit P/N 41420-08.

<b>43621-09</b>	Mirror Chrome.	<b>\$549.95</b>
<b>43300049</b>	Cut Back Gloss Black.	<b>\$449.95</b>

### 17" Rear

Fits '06-later FXST, FXSTB, FXSTC, FLSTF, FLSTFB and FLSTSB models.

<b>40803-09</b>	Mirror Chrome.	<b>\$549.95</b>
<b>40900061</b>	Cut Back Gloss Black.	<b>\$449.95</b>

Fits '06-later Dyna models (except FXDF and FXDFSE/2) and '00-'07 FXSTD models.

<b>43636-09</b>	Mirror Chrome.	<b>\$549.95</b>
<b>40900059</b>	Cut Back Gloss Black.	<b>\$449.95</b>



A. MAGNUM 5 CUSTOM WHEEL – 21" MIRROR CHROME



Mirror Chrome  
Magnum 5 Wheel



Cut Back Gloss Black  
Magnum 5 Wheel

See pages 692 for matching Magnum 5 Sprocket Covers.



A. MAGNUM 5 CUSTOM WHEEL – 19" CUT BACK GLOSS BLACK

Notice: The prices appearing in this catalog are the manufacturer's suggested retail prices. Actual retail prices may vary.

**B**



**B. TYPHOON CUSTOM WHEEL – 21" MIRROR CHROME**

**B. TYPHOON CUSTOM WHEEL**

An intense storm is brewing. Nine arching spokes spin outward from the hub and blend seamlessly with the rim to add forward motion, even while standing still. The flat profile spokes and carved webs add visual intensity and the available mirror chrome or cut back gloss black finishes let you tailor your bike to fit the mood. These cast aluminum wheels have undergone hundreds of hours of real-world testing to meet the highest standards of performance and durability. Requires separate purchase of model-specific Wheel Installation Kit, sprocket hardware and brake rotor-specific hardware. See I-sheet for details. Installation may require separate purchase of wheel size and model-specific tire.

**21" Front**

Fits '00-later FXS, FXST, FXSTD (except FXSTDSE), FXSTS, FXSTB, FXSTC and '00-later FXDWG and '08 FXDSE2 models.

<b>40882-08</b>	Mirror Chrome.	<b>\$549.95</b>
<b>43300055</b>	Cut Back Gloss Black.	<b>\$449.95</b>

**19" Front**

Fits '06-later Dyna® models (except FLD, FXDWG, FXDF and FXDFSE/2). Installation on models equipped with Original Equipment laced wheel will require separate purchase of Floating Brake Rotor. Does not fit with chrome Front Wheel Spacer Kit P/N 41420-08.

<b>44615-08</b>	Mirror Chrome.	<b>\$549.95</b>
<b>43300053</b>	Cut Back Gloss Black.	<b>\$449.95</b>

**17" Rear**

Fits '08-later FXST, FXSTB, FXSTC, FLSTF, FLSTFB and FLSTSB models.

<b>40884-08</b>	Mirror Chrome.	<b>\$549.95</b>
<b>40900065</b>	Cut Back Gloss Black.	<b>\$449.95</b>

**17" Rear**

Fits '06-later Dyna models (except FXDF and FXDFSE/2) and '00-'07 FXSTD models.

<b>44617-08</b>	Mirror Chrome.	<b>\$549.95</b>
<b>40900063</b>	Cut Back Gloss Black.	<b>\$449.95</b>

**B**



**B. TYPHOON CUSTOM WHEEL – 19" CUT BACK GLOSS BLACK**



**Mirror Chrome  
Typhoon Wheel**



**Cut Back Gloss Black  
Typhoon Wheel**

See pages 692 for matching Typhoon Sprocket Covers.

WHEELS

*Notice: The prices appearing in this catalog are the manufacturer's suggested retail prices. Actual retail prices may vary.*

# 682 WHEELS

Slotted 6-Spoke

## A. SLOTTED 6-SPOKE WHEEL

A dramatic look that breaks the mold in motorcycle wheel styling. Available in black or chrome, this stylish custom wheel incorporates the strength of twelve spokes into the illusion of a lightweight six spoke design. Textured fingerlike slots radiate from the center to the uniquely rounded smooth finishes on the inner and outer rim. The combination of polished and textured finishes on the spokes, rim and hub fool the eye and add to the sleek appearance, while the premium quality cast aluminum construction reduces weight without compromising strength. Matching brake rotors and sprockets are available for a complete custom look. All Genuine Motor Accessory wheels have been certified by Harley-Davidson to perform to our tough vehicle standards for quality and durability. Requires separate purchase of model-specific Wheel Installation Kit, sprocket hardware and brake rotor-specific hardware. See I-sheet for details. Installation may require separate purchase of wheel size and model-specific tire.

### 21" Front

Fits '00-later FXS, FXST, FXSTD (except FXSTDSE), FXSTS, FXSTB, FXSTC and '00-later FXDWG and '08 FXDSE2 models.

<b>43924-07</b>	Textured Chrome.	<b>\$549.95</b>
<b>43925-07</b>	Textured Black.	<b>\$399.95</b>
<b>43973-08</b>	Mirror Chrome.	<b>\$749.95</b>

Fits '00-later XL (except XL1200X, '11-later XL883L and XL1200C) and '00-'05 Dyna® models (except FXDWG).

<b>44055-07</b>	Textured Chrome.	<b>\$549.95</b>
<b>44056-07</b>	Textured Black.	<b>\$399.95</b>

### 19" Front

Fits '06-later Dyna models (except FLD, FXDWG, FXDF and FXDFSE/2). Installation on models equipped with Original Equipment cast wheel will require separate purchase of Floating Brake Rotor.

<b>43538-09</b>	Mirror Chrome.	<b>\$749.95</b>
<b>43577-09</b>	Textured Black.	<b>\$399.95</b>

Fits '00-later XL (except XL1200X, '11-later XL883L and XL1200C) and '00-'05 Dyna models (except FXDWG).

<b>44058-07</b>	Textured Chrome.	<b>\$549.95</b>
<b>44057-07</b>	Textured Black.	<b>\$399.95</b>

### 16" Front

Fits '00-'08 Touring models. Also fits '09-later FLHRC models.

<b>43920-08</b>	Textured Chrome.	<b>\$549.95</b>
<b>43921-08</b>	Textured Black.	<b>\$399.95</b>

Fits '00-later FLST, FLSTC, FLSTN and '00-'06 FLSTF models (except '06 FLSTFSE2).

<b>43918-07</b>	Textured Chrome.	<b>\$549.95</b>
<b>43919-07</b>	Textured Black.	<b>\$399.95</b>

### 16" Rear

Fits '03-'07 FLST, FLSTN and FLSTC, '03-'06 FLSTF (except FLSTFSE2) and '03-'05 FXST, FXSTB and FXSTS models.

<b>43930-08</b>	Textured Chrome.	<b>\$549.95</b>
<b>43931-08</b>	Textured Black.	<b>\$399.95</b>

Fits '00-later XL (except '11-later XL883L), '00-'05 Dyna, '00-'02 Softail® models (except FXSTD) and '00-'08 Touring models.

<b>43928-08</b>	Textured Chrome.	<b>\$549.95</b>
<b>43929-08</b>	Textured Black.	<b>\$399.95</b>

Fits '08-later FXS, FLSTN and FLSTC models.

<b>40827-08</b>	Textured Black.	<b>\$399.95</b>
-----------------	-----------------	-----------------

### 17" Rear

Fits '06-later Dyna (except FXDF and FXDFSE/2) and '00-'07 FXSTD models.

<b>43934-07</b>	Textured Chrome.	<b>\$549.95</b>
<b>43942-07</b>	Textured Black.	<b>\$399.95</b>
<b>43972-08</b>	Mirror Chrome.	<b>\$749.95</b>

See pages 693-694 for matching Slotted 6-Spoke Rotors and Sprockets.



A. SLOTTED 6-SPOKE WHEEL – 21" TEXTURED CHROME



A. SLOTTED 6-SPOKE WHEEL – 16" TEXTURED BLACK

Notice: The prices appearing in this catalog are the manufacturer's suggested retail prices. Actual retail prices may vary.

# WHEELS 683

Slotted 6-Spoke/Stinger



A

A. SLOTTED 6-SPOKE WHEEL – 21" MIRROR CHROME



B

B. STINGER CUSTOM WHEEL – 18" SOFTAIL

## B. STINGER CUSTOM WHEEL

Scratch your customizing itch. This cutting edge 5-spoke Stinger Wheel is designed to draw your eye and hold your attention. The spiral spokes radiate from the fluted hub imparting a sense of motion, and their slim cross section creates an open and airy profile. These fully polished and mirror-chrome finished 18" wheels feature a deeply notched rim that adds visual interest, and can be accented with matching Stinger Sprockets and custom wave-accented Floating Brake Rotors. These cast aluminum wheels have undergone hundreds of hours of real-world testing to meet the highest standards of performance and durability. Requires separate purchase of model-specific Wheel Installation Kit, sprocket hardware and brake rotor-specific hardware. See I-sheet for details. Installation may require separate purchase of wheel size and model-specific tire.

### 18" Front

**47831-10** **\$749.95**

Fits '08-later FXDF and FXDFSE/2 models.

**41503-10** **\$749.95**

Fits '08-later FLSTF, FLSTFB and FLSTSB models.

### 18" Rear

**47835-10** **\$749.95**

Fits '08-later FXDF and FXDFSE/2 models.

**41509-10** **\$749.95**

Fits '08-later FXST, FXSTB, FXSTC, FLSTF, FLSTFB and FLSTSB models.



Mirror Chrome  
Stinger Wheel

See pages 693-695 for matching Stinger Rotors and Sprockets.

# 684 WHEELS

ThunderStar™

## A. THUNDERSTAR™ CUSTOM WHEEL

Impressive styling and performance all rolled into one, these premium quality cast aluminum wheels are named for their striking 5-spoke design. Available in three different finishes, these wheels offer a captivating style. The mirror chrome wheels feature chrome-plated polished surfaces for a glass-smooth look, and the textured chrome wheels feature complementing chrome-plated polished spokes and textured webs for a light-grabbing finish. Finish the look by adding matching ThunderStar™ Floating Brake Rotors. All Genuine Motor Accessory wheels have been certified by Harley-Davidson to perform to our tough vehicle standards for quality and durability. Requires separate purchase of model-specific Wheel Installation Kit, sprocket hardware and brake rotor-specific hardware. See I-sheet for details. Installation may require separate purchase of wheel size and model-specific tire.

### 21" Front

Fits '00-later FXS, FXST, FXSTD (except FXSTDSE), FXSTS, FXSTB, FXSTC and '00-later FXDWG.

<b>43975-07</b>	Textured Chrome.	<b>\$549.95</b>
<b>43773-07</b>	Textured Black.	<b>\$399.95</b>
<b>43602-07</b>	Mirror Chrome.	<b>\$749.95</b>

### 19" Front

Fits '00-later XL (except XL1200X, '11-later XL883L and XL1200C) and '00-'05 Dyna® models (except FXDWG).

<b>44323-07</b>	Textured Chrome.	<b>\$549.95</b>
<b>44322-07</b>	Textured Black.	<b>\$399.95</b>
<b>44282-07</b>	Mirror Chrome.	<b>\$749.95</b>

### 17" Front

Fits '09-later Touring models (except Trike and '12 CVO™ models).

<b>40943-09</b>	Textured Chrome.	<b>\$549.95</b>
<b>40966-09</b>	Mirror Chrome.	<b>\$749.95</b>

### 16" Front

Fits '00-later FLST, FLSTC, FLSTN and '00-'06 FLSTF models (except '06 FLSTFSE2).

<b>43978-07</b>	Textured Chrome.	<b>\$549.95</b>
<b>43771-07</b>	Textured Black.	<b>\$399.95</b>
<b>43609-07</b>	Mirror Chrome.	<b>\$749.95</b>

Fits '00-'08 Touring models. Also fits '09-later FLHRC models.

<b>43573-08</b>	Textured Chrome.	<b>\$549.95</b>
<b>43575-08</b>	Textured Black.	<b>\$399.95</b>
<b>43703-08</b>	Mirror Chrome.	<b>\$749.95</b>

### 16" Rear

Fits '08-later FXS, FLSTN and FLSTC models.

<b>40833-08</b>	Textured Black.	<b>\$399.95</b>
<b>40835-08</b>	Mirror Chrome.	<b>\$749.95</b>

Fits '09-later Touring models (except Trike and '12 CVO models).

<b>40880-09</b>	Textured Chrome.	<b>\$549.95</b>
<b>40881-09</b>	Mirror Chrome.	<b>\$749.95</b>

Fits '00-later XL (except '11-later XL883L), '00-'05 Dyna, '00-'02 Softail® (except FXSTD) and '00-'08 Touring models.

<b>43979-08</b>	Textured Chrome.	<b>\$549.95</b>
<b>43780-08</b>	Textured Black.	<b>\$399.95</b>
<b>43649-08</b>	Mirror Chrome.	<b>\$749.95</b>

Fits '03-'07 FLST, FLSTN, FLSTC, '03-'06 FLSTF (except FLSTFSE2) and '03-'05 FXST, FXSTB and FXSTS models.

<b>43794-08</b>	Textured Chrome.	<b>\$549.95</b>
<b>43795-08</b>	Textured Black.	<b>\$399.95</b>
<b>44544-08</b>	Mirror Chrome.	<b>\$749.95</b>

See pages 693-694 for matching ThunderStar Rotors and Sprockets.



A. THUNDERSTAR CUSTOM WHEEL – 21" MIRROR CHROME



A. THUNDERSTAR CUSTOM WHEEL – 21" TEXTURED CHROME

Notice: The prices appearing in this catalog are the manufacturer's suggested retail prices. Actual retail prices may vary.

# WHEELS 685

ThunderStar™/Reaper



A. THUNDERSTAR CUSTOM WHEEL – 21" TEXTURED BLACK



B. REAPER CUSTOM WHEEL – 21"

## B. REAPER CUSTOM WHEEL

Step out from behind the black shroud. Brilliant chrome-plated cast wheels feature a forward slashing scythe design that radiates from the compact center hub. Honed to a "razor's edge," the 5 curved blade spokes blend with the rim to provide a look of continuous motion. Cast of premium quality aluminum, the polished hub, spokes and rim are polished to a mirror finish before they are drenched in chrome. Matching sprockets are available for a complete custom look. Requires separate purchase of model-specific Wheel Installation Kit, sprocket hardware and brake rotor-specific hardware. See I-sheet for details. Installation may require separate purchase of wheel size and model-specific tire.

**21" Front**  
**40778-08** **\$749.95**

Fits '00-later FXS, FXST, FXSTD (except FXSTDSE), FXSTS, FXSTB, FXSTC and '00-later FXDWG models. Also fits '08 FXDSE2 models.

**18" Front**  
**40790-09** **\$749.95**

Fits '04-later Touring models (except Trike and '12 CVO™ models). Requires separate purchase of Open Brake Rotors. See your Dealer or the instruction sheet for specific part numbers.

**19" Front**  
**41983-08** **\$749.95**

Fits '06-later Dyna® models (except FLD, FXDWG, FXDF and FXDFSE/2). Installation on models equipped with Original Equipment laced wheel will require separate purchase of Floating Brake Rotor.

**17" Front**  
**40779-08** **\$749.95**

Fits '08-later FLSTF and FLSTFB models. Recommend separate purchase of Floating Brake Rotor.

**17" Rear**  
**40802-08** **\$749.95**

Fits '08-later FXST, FXSTB, FXSTC, FLSTF, FLSTFB and FLSTSB models.

**41981-08** **\$749.95**

Fits '06-later Dyna models (except FXDF and FXDFSE/2) and '00-'07 FXSTD models.

**16" Rear**  
**40792-09** **\$749.95**

Fits '09-later Touring models (except Trike and '12 CVO models).



Mirror Chrome  
Reaper Wheel

See pages 693-694 for matching Reaper Rotors and Sprockets.

Notice: The prices appearing in this catalog are the manufacturer's suggested retail prices. Actual retail prices may vary.

# 686 WHEELS

Road Winder™

## A. ROAD WINDER™ CUSTOM WHEEL

Take your custom ride in a new direction. The directional spokes of the one-piece Road Winder™ Wheel add the look of forward motion even while standing still. The slim spokes open the wheel visually, and showcase the available matching brake rotors and sprockets. Forged from 6061 aluminum, these wheels are available in brilliant chrome finish. The forged surfaces resist the elements, and are easy to clean and maintain. All Genuine Motor Accessory wheels have been certified by Harley-Davidson to perform to our tough vehicle standards for quality and durability. Matching brake rotors and sprockets are available for a complete custom look. Requires separate purchase of model-specific Wheel Installation Kit, sprocket hardware and brake rotor-specific hardware. See I-sheet for details.

### 18" Front

**44612-07** Mirror Chrome. **\$1,199.95**  
Fits '04-'08 Touring models (except Trike). Requires separate purchase of Brake Rotors. See your Dealer or the instruction sheet for specific part numbers.

### 16" Rear

**44636-08** Mirror Chrome. **\$1,249.95**  
Fits '00-'05 Dyna®, '00-'02 Softail® (except FXSTD) and '00-'08 Touring models.

See pages 693-694 for matching Road Winder Rotors and Sprockets.

## B. CHROME 80-SPOKE LACED CUSTOM WHEEL

Add a contemporary custom look to a nostalgic motorcycle. These classic laced wheels feature 80 chrome-plated spokes set in a traditional 4-cross spoke pattern. The chrome-plated steel rim and aluminum hub are laced with chrome-plated steel spokes and nipples. Each wheel includes rubber rim strip. Requires separate purchase of model-specific Wheel Installation Kit, Sprocket hardware and Brake Rotor-specific hardware. See I-sheet for details.

### 21" Front

**41203-05** **\$724.95**  
Fits '00-'07 FXST, FXSTD (except FXSTDSE), FXSTS, FXSTB, FXSTC and '00-'07 FXDWG models.

### 16" Front

**42958-07** **\$724.95**  
Fits '00-later FLST, FLSTC, FLSTN and '00-'06 FLSTF models (except '06 FLSTFSE2).

### 16" Rear

**42962-08** **\$724.95**  
Fits '03-'07 FLST, FLSTN and FLSTC, '03-'06 FLSTF (except FLSTFSE2) and '03-'05 FXST, FXSTB and FXSTS models.

**40750-08** **\$724.95**  
Fits '08-later FXS, FLSTN and FLSTC models.



A. ROAD WINDER CUSTOM WHEEL – MIRROR CHROME



B. CHROME 80-SPOKE LACED CUSTOM WHEEL – 16"

Notice: The prices appearing in this catalog are the manufacturer's suggested retail prices. Actual retail prices may vary.

NEW

C

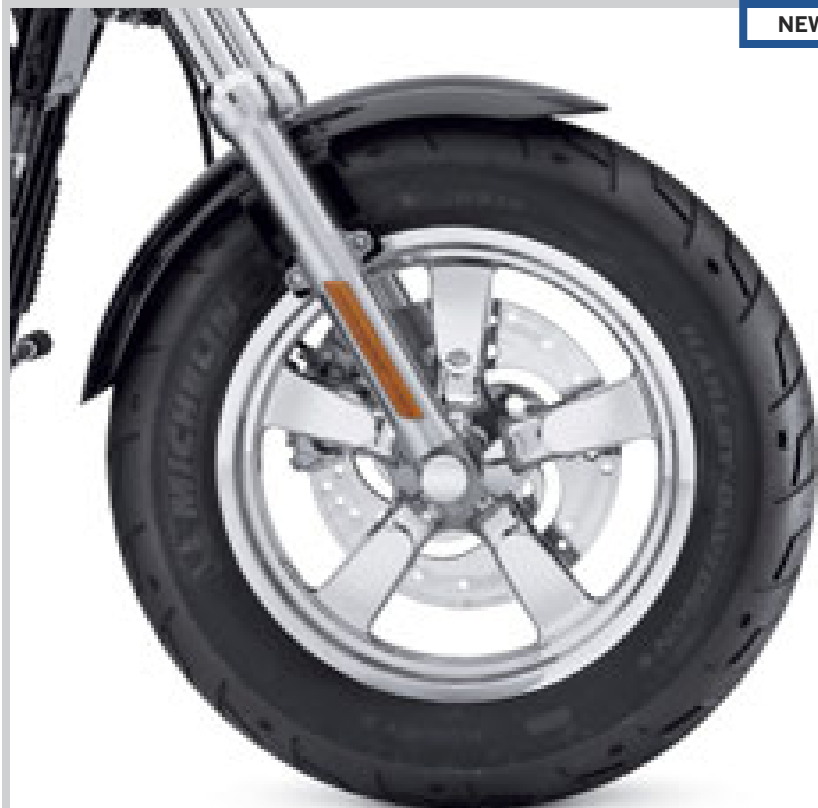

C. FAT-X 5-SPOKE WHEEL – 16" MIRROR CHROME

### C. FAT-X 5-SPOKE WHEEL – MIRROR CHROME

Add a splash of chrome without changing the distinctive custom style of your Sportster®. More than just a chrome-plated Original Equipment wheel, these 5-spoke wheels utilize tooling developed specifically for chrome-plating to give a near perfect finish without the “waves” created when polishing the Original Equipment cast wheel. Countless hours of polishing result in a superior finish. Special masking was developed to prevent plating corrosion inside bolt holes and bearing sleeve areas. All Genuine Motor Accessory wheels have been certified by Harley-Davidson to perform to our tough vehicle standards for quality and durability. Requires separate purchase of model-specific Wheel Installation Kit.

**43300045** 16" Front. **\$449.95**  
Fits '10-later XL1200X and '11-later XL1200C models.

**40900055** 16" Rear. **\$449.95**  
Fits '08-later XL models (except '11-later XL883L).



Mirror Chrome  
Fat-X Wheel

See pages 693-695 for custom sprocket and brake rotor options.

D



D. 5-SPOKE ROCKER WHEEL – 19" CHROME

### D. 5-SPOKE ROCKER™ WHEELS – CHROME

Add the brilliance of chrome without changing the distinctive custom style of your Rocker™ motorcycle. This meticulously polished and chrome-plated version of the Original Equipment 5-spoke cast aluminum wheel casts glowing reflections, even while standing still. These wheels, chromed to the same strict standards you have come to expect from Harley-Davidson, are plated using custom masking that provides contamination-free bolt holes and bearing bores. This allows the installed bearings to fit as precisely as on our Original Equipment wheels, so you can be confident these wheels will ride as smooth as they look. Requires separate purchase of model-specific Wheel Installation Kit, sprocket hardware and brake rotor-specific hardware. See I-sheet for details.

**43300001** 19" Front. **\$349.95**  
Fits '08-'11 FXCW and FXCWC models.

**40900001** 18" Rear. **\$349.95**  
Fits '08-'11 FXCW and FXCWC models.



Mirror Chrome 5-Spoke  
Rocker Wheel

See pages 693-695 for custom sprocket and brake rotor options.

## 688 WHEELS

Vapor/Switchblade

### A. VAPOR 5-SPOKE CUSTOM WHEEL – MIRROR CHROME

Add a splash of chrome without changing the distinctive custom style of your Switchback™ motorcycle. Countless hours of polishing result in a superior finish. These cast aluminum wheels have undergone hundred of hours of real-world testing to meet the highest standards of performance and durability. Requires separate purchase of model-specific Wheel Installation Kit, sprocket hardware and brake rotor-specific hardware. See I-sheet for details.

**43300067** 18" Front. **\$449.95**  
Fits '12 FLD models.

**40900077** 17" Rear. **\$449.95**  
Fits '08-later Dyna® models (except FXDF and FXDFSE/2).



Vapor-5 Spoke  
Mirror Chrome Wheel

See pages 693-695 for custom sprocket and brake rotor options.



A. VAPOR 5-SPOKE CUSTOM WHEEL – 18" MIRROR CHROME

### B. SWITCHBLADE CUSTOM WHEEL – MIRROR CHROME

Add the brilliance of chrome without changing the distinctive custom style of your Dyna motorcycle. This meticulously polished and chrome-plated version of the Original Equipment 10-spoke cast aluminum wheel casts glowing reflections, even while standing still. These wheels, chromed to the same strict standards you have come to expect from Harley-Davidson, are plated using custom masking that provides contamination-free bolt holes and bearing bores. This allows the installed bearings to fit as precisely as on our Original Equipment wheels, so you can be confident these wheels will ride as smooth as they look. Requires separate purchase of model-specific Wheel Installation Kit, sprocket hardware and brake rotor-specific hardware. See I-sheet for details.

**40359-10** 19" Front. **\$449.95**  
Fits '08-later Dyna models (except FLD, FXDWG, FXDF and FXDFSE/2). Installation on models equipped with Original Equipment laced wheel will require separate purchase of model-specific Floating Brake Rotor.

**40386-10** 17" Rear. **\$449.95**  
Fits '08-later Dyna models (except FXDF and FXDFSE/2).



Mirror Chrome  
Switchblade Wheel

See pages 693-695 for custom sprocket and brake rotor options.



B. SWITCHBLADE CUSTOM WHEEL – 19" MIRROR CHROME

Notice: The prices appearing in this catalog are the manufacturer's suggested retail prices. Actual retail prices may vary.

# WHEELS 689

Fang/Fat Bob®



C

### C. FANG CUSTOM WHEEL

Something to sink your teeth into. This custom disc wheel features a unique contrast chrome and black finish. First, the cast wheel is painted to a deep luster, then it is machined to expose the bare metal, and finally chrome-plated for a brilliant shine. This reverse process leaves crisp contrast lines without the rough masking lines of some other painted chrome wheels. Chrome-plated bolt-in "saber fang" inserts add a finishing touch. Requires separate purchase of model-specific Wheel Installation Kit, sprocket hardware and brake rotor-specific hardware. See I-sheet for details.

Fits '08-later FXDF and FXDFSE/2 models.

<b>43265-09</b>	16" Front.	<b>\$749.95</b>
<b>43268-09</b>	16" Rear.	<b>\$749.95</b>



**Contrast Chrome Fang Wheel**

See pages 693-695 for custom sprocket and brake rotor options.

**C. FANG CUSTOM WHEEL – 16" (SHOWN WITH CLASSIC BLACK FLOATING BRAKE ROTOR)**



NEW

D

### D. FAT BOB® SLOTTED CUSTOM WHEEL – GLOSS BLACK CUT BACK

Come to the dark side. Add a sinister blacked-out look without changing the distinctive style of the Fat Bob® motorcycle. The Original Equipment slotted wheels are finished to a deep gloss black luster, and then meticulously machined to expose the raw aluminum below. The contrasting aluminum beveled edge slots and accent spots add a genuine custom look without compromising strength or performance. All Genuine Motor Accessory wheels have been certified by Harley-Davidson to perform to our tough vehicle standards for quality and durability. Requires separate purchase of model-specific Wheel Installation Kit.

Fits '08-later FXDF and FXDFSE/2 models.

<b>43300065</b>	16" Front.	<b>\$399.95</b>
<b>40900075</b>	16" Rear.	<b>\$399.95</b>



**Cut Back Gloss Black Slotted Wheel**

See pages 693-695 for custom sprocket and brake rotor options.

**D. FAT BOB SLOTTED CUSTOM WHEEL – 16" GLOSS BLACK CUT BACK (SHOWN WITH CLASSIC BLACK FLOATING BRAKE ROTOR)**

WHEELS

Notice: The prices appearing in this catalog are the manufacturer's suggested retail prices. Actual retail prices may vary.

# 690 WHEELS

Disc

## A. SOLID DISC WHEEL – MIRROR CHROME

The smooth surface is almost like glass, with a “see-through” look you’ll want to reach out and touch. Requires separate purchase of model-specific Wheel Installation Kit, Sprocket hardware and brake rotor-specific hardware. See I-sheet for details.

**41271-07** 16" Front. **\$749.95**  
Fits '00-later FLST, FLSTC, FLSTN and '00-'06 FLSTF models (except '06 FLSTFSE2).

**41274-08** 16" Front. **\$749.95**  
Fits '00-'08 Touring models. Also fits '09-later FLHRC models.

**41262-08** 16" Rear. **\$749.95**  
Fits '00-later XL (except '11-later XL883L), '00-'05 Dyna®, '00-'02 Softail® (except FXSTD) and '00-'08 Touring models.

**41265-08** 16" Rear. **\$749.95**  
Fits '03-'07 FLST, FLSTN, FLSTC, '03-'06 FLSTF (except FLSTFSE2) and '03-'05 FXST, FXSTB and FXSTS models.

## B. SLOTTED DISC WHEEL – TEXTURED CHROME

The polished rim and textured disc are divided by a ring of slots that open the wheel for a flash of light. Requires separate purchase of model-specific Wheel Installation Kit, Sprocket hardware and brake rotor-specific hardware. See I-sheet for details.

**41022-07** 16" Front. **\$449.95**  
Fits '00-later FLST, FLSTC, FLSTN and '00-'06 FLSTF models (except '06 FLSTFSE2).

**41261-08** 16" Rear. **\$449.95**  
Fits '03-'07 FLST, FLSTN, FLSTC, '03-'06 FLSTF (except FLSTFSE2) and '03-'05 FXST, FXSTB and FXSTS models.

**41013-00A** 16" Rear. **\$605.95**  
Fits '00-'04 XL, '00-'05 Dyna, '00-'02 Softail (except FXSTD and FLSTS) and '00-'01 Touring models.

**41013-95** 16" Rear. **\$398.95**  
Fits '86-'99 XL, Softail, FXR and '91-'99 Dyna models.

## C. SOLID FAT BOY® CHROME WHEEL

Meticulously chrome-plated, this Fat Boy® wheel adds a distinctive custom touch. Requires separate purchase of model-specific Wheel Installation Kit, Sprocket hardware and brake rotor-specific hardware. See I-sheet for details.

**41031-07** 16" Front. **\$449.95**  
Fits '00-later FLST, FLSTC, FLSTN and '00-'06 FLSTF models (except '06 FLSTFSE2).

**41026-08** 16" Rear. **\$449.95**  
Fits '00-later XL (except '11-later XL883L), '00-'05 Dyna, '00-'02 Softail (except FXSTD) and '00-'08 Touring models.

**41260-08** 16" Rear. **\$449.95**  
Fits '03-'07 FLST, FLSTN, FLSTC, '03-'06 FLSTF (except FLSTFSE2) and '03-'05 FXST, FXSTB and FXSTS models.

## D. CHROME WHEEL FOR SOFTAIL® DEUCE™ MODELS

This meticulously polished and chrome-plated version of the Original Equipment solid rear wheel retains the raised rib design. Requires separate purchase of model-specific Wheel Installation Kit, Sprocket hardware and brake rotor-specific hardware. See I-sheet for details.

**41174-07** 17" Rear. **\$749.95**  
Fits '00-'07 FXSTD and '06-later Dyna models (except FXDF and FXDFSE/2).

## E. BLACK CAST SLOTTED DISC WHEEL

Original Equipment on Street Glide® FLHX models. These Slotted Disc Wheels feature a black center and a contrasting machined rim that add an aggressive look to your Touring motorcycle. Wheels come without bearings.

**41285-09** 17" Front. **\$499.95**  
Fits '09-later Touring models (except Trike).

**41285-06** 16" Front. **\$499.95**  
Fits '00-'08 Touring models.

**41288-09** 16" Rear. **\$499.95**  
Fits '09-later Touring models (except Trike).

**41288-06A** 16" Rear. **\$499.95**  
Fits '02-'08 Touring models.



A. SOLID DISC WHEEL – 16" MIRROR CHROME



B. SLOTTED DISC WHEEL – 16" TEXTURED CHROME

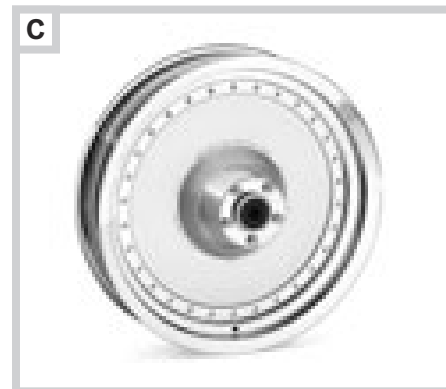

C. SOLID FAT BOY CHROME WHEEL



D. CHROME REAR WHEEL FOR SOFTAIL DEUCE MODELS



E. BLACK CAST SLOTTED DISC WHEEL ('00-'08 SHOWN)

See pages 693-695 for custom sprocket and brake rotor options.

Notice: The prices appearing in this catalog are the manufacturer's suggested retail prices. Actual retail prices may vary.

NEW

F



**F. V-ROD 5-SPOKE WHEEL – 19" BLACK ICE**

**F. V-ROD® 5-SPOKE WHEEL – BLACK ICE**

Brawn is back. Five big and beefy spokes define the distinctive hot rod styling, and the knife-edge shape provides an angular spin on the traditional custom wheel look. Treated to the exclusive black ice finish, these mirror-smooth wheels add an incredible depth and shimmer that is impossible to reach with an ordinary "black chrome" finish. Pick your styling direction – the rich black finish blends easily into a blacked-out bike, but the wet-look shimmer holds its own in the company of chrome as well. All Genuine Motor Accessory wheels have been certified by Harley-Davidson to perform to our tough vehicle standards for fit, quality and durability. Wheel kits require separate purchase of model-specific Wheel Installation Kit, sprocket hardware and brake rotor-specific hardware. See I-sheet for details.

Fits '09-later VRSCF models and '12 VRSCDX models.

<b>55083-11</b>	19" Front.	<b>\$549.95</b>
<b>55082-11</b>	18" Rear.	<b>\$649.95</b>

**G. REACTOR CUSTOM WHEEL**

The 5 slim spokes of this custom wheel dramatically change the look of the VRSC™ motorcycle. Available in mirror-chrome or gloss black, the "ball-milled" spokes radiate from the unique center hub to blend with the machined rim, opening the bike for a light, sporting profile. The smooth curving rim, highlighted with machined grooves, adds to the true custom look without compromising strength or performance. The raised bosses on the hub carry the Original Equipment floating brake rotors, and add to the clean appearance of the installed wheel.

**19" Front**

Fits '02-'11 VRSCA, VRSCB, VRSCD, VRSCDX, VRSCX and VRSCSE/2. Requires separate purchase of model-specific Wheel Installation Kit. '07 VRSCX, '08 VRSCAW Anniversary models, and other models equipped with laced front wheels also require additional purchase of (2) Front Brake Rotors.

<b>43219-08</b>	Chrome.	<b>\$1,199.95</b>
<b>43501-08</b>	Gloss Black/Orange Stripe.	<b>\$1,199.95</b>

**18" Rear (240 Tire)**

Fits '07-later VRSC models (except '07-'08 VRSCD and '07 VRSCR). Requires separate purchase of model-specific Wheel Installation Kit.

<b>43728-08</b>	Chrome.	<b>\$1,399.95</b>
<b>43616-08</b>	Gloss Black/Orange Stripe.	<b>\$1,399.95</b>

**18" Rear (180/55 Tire)**

Fits '02-'06 VRSCA and VRSCB models, '06-'08 VRSCD and '05-'07 VRSCR models. Requires separate purchase of model-specific Wheel Installation Kit.

<b>43215-08</b>	Chrome.	<b>\$1,199.95</b>
-----------------	---------	-------------------

**H. REACTOR BILLET SPROCKET**

Styled to complement the Reactor Custom Wheels for VRSC models, the 5 thin spokes mirror the design of the wheel and add a light profile to the rear of the bike.

Fits '07-later VRSC models (except VRSCR). Separate purchase of bearing is required.

<b>40161-09</b>	Chrome.	<b>\$499.95</b>
<b>40162-09</b>	Gloss Black/Orange Stripe.	<b>\$499.95</b>

Fits '02-'06 VRSC models (except '06 VRSCSE2). Also fits '07 VRSCR models.

<b>40229-04</b>	Chrome.	<b>\$499.95</b>
-----------------	---------	-----------------

**I. REACTOR SPROCKET COMPENSATOR BOWL**

Show off the back of your Reactor Wheel and Sprocket combination. This chrome-plated Sprocket Compensator Bowl replaces the Original Equipment painted part, and dresses up the view when you look through the open design of the Reactor Custom Wheel. Kit reuses Original Equipment compensator cushion.

Fits '07-later VRSC models (except VRSCR) equipped with Reactor Custom Rear Wheel.

<b>40169-09</b>	Gloss Black.	<b>\$49.95</b>
<b>40168-09</b>	Chrome.	<b>\$49.95</b>

Fits '02-'06 VRSC models (except '06 VRSCSE2) and '07 VRSCR and '07-'08 VRSCD models equipped with Reactor Custom Wheel.

<b>40541-05</b>	Chrome.	<b>\$49.95</b>
-----------------	---------	----------------



G

**G. REACTOR CUSTOM WHEEL – CHROME**



G

**G. REACTOR CUSTOM WHEEL – GLOSS BLACK/ORANGE STRIPE**



H

**H. REACTOR BILLET SPROCKET – CHROME AND GLOSS BLACK/ORANGE STRIPE**



I

**I. REACTOR SPROCKET COMPENSATOR BOWL – CHROME AND GLOSS BLACK**

# 692 WHEELS

## Sprocket Covers

### A. MAGNUM 5 SPROCKET COVER

Styled to match the distinctive Magnum 5 Custom Wheel. Available in mirror-chrome or gloss black, this Sprocket Cover gives the appearance of having a custom sprocket at a fraction of the cost. Cover is easy to install with Original Equipment hardware, or add the Chrome Hardware Kit P/N 94773-07 to your Dyna® or Softail® model for a finished look (*sold separately*).

Fits '07-later Dyna models.

<b>40120-09</b>	Chrome.	<b>\$54.95</b>
<b>42200010</b>	Gloss Black.	<b>\$54.95</b>

Fits '07-later Softail (except FXCW/C) and '07 Touring models.

<b>40121-09</b>	Chrome.	<b>\$54.95</b>
<b>42200011</b>	Gloss Black.	<b>\$54.95</b>

### B. TYPHOON SPROCKET COVER

Styled to match the distinctive Typhoon Custom Wheel. Available in mirror-chrome or gloss black, this Sprocket Cover gives the appearance of having a custom sprocket at a fraction of the cost. Cover easily bolts on using the stock hardware or for a finished look, add the Chrome Hardware Kit P/N 94773-07 (*sold separately*).

Fits '07-later Softail models (except FXCW/C).

<b>40150-08</b>	Chrome.	<b>\$49.95</b>
<b>42200013</b>	Gloss Black.	<b>\$49.95</b>

Fits '07-later Dyna models.

<b>40142-08</b>	Chrome.	<b>\$49.95</b>
<b>42200012</b>	Gloss Black.	<b>\$49.95</b>

### C. CHROME SPROCKET COVER

This Sprocket Cover gives the appearance of having a chrome sprocket at a fraction of the cost. It matches the styling of the Original Equipment sprocket and bolts on using the stock hardware.

**37757-07** **\$49.95**

Fits '07-later Softail (except FXCW/C) and '07 Touring models.

**91347-00** **\$49.95**

Fits '00-'06 Softail models.

### D. CHROME "BIG SPOKE" SPROCKET COVER

Muscle rules. Big, beefy spokes define the distinctive hot rod styling, and the small trapezoidal openings are reminiscent of the Detroit's street performance wheels of the late '60s. The chrome-plated steel cover disguises the Original Equipment sprocket and complements both stock and custom wheels. Easy to install, this cover provides the look of a billet sprocket at a fraction of the cost.

**40124-10** **\$49.95**

Fits '04-later XL and XR models.



A. MAGNUM 5 SPROCKET COVER – CHROME



A. MAGNUM 5 SPROCKET COVER – CHROME AND GLOSS BLACK



B. TYPHOON SPROCKET COVER – CHROME



B. TYPHOON SPROCKET COVER – CHROME AND GLOSS BLACK



C. CHROME SPROCKET COVER



D. CHROME "BIG SPOKE" SPROCKET COVER

*Notice: The prices appearing in this catalog are the manufacturer's suggested retail prices. Actual retail prices may vary.*



Slotted 6-Spoke



Road Winder



Reaper



Revolver



Chrome ThunderStar



Blade



Stinger



Detonator



Mirror Chrome Disc



Fang



Mirror Disc



Cut Back Gloss Black

**E. BILLET SPROCKETS**

Designed to complement the wheel's styling, these custom sprockets are manufactured from 6061-T6 forged billet aircraft aluminum, and precision machined to exacting Original Equipment standards. Harley-Davidson® custom sprockets are finished with a proprietary process that combines the decorative chrome with a wear-resistant surface applied to the teeth. The sprockets feature a five-year tooth wear warranty.

Fits '04-later XL and '09-later XR models (except Japanese models). Requires separate purchase of model-specific sprocket mounting hardware.

**40418-04** Slotted 6-Spoke. **\$399.95**

Fits '00-'05 Dyna® models. Requires separate purchase of model-specific sprocket mounting hardware.

**40451-01** Slotted 6-Spoke. **\$399.95**

**40096-00** Chrome ThunderStar™. **\$399.95**

Fits '07-later Dyna models (except Japanese models). Requires separate purchase of model-specific sprocket mounting hardware.

**40451-07** Slotted 6-Spoke. **\$399.95**

**40478-07** Road Winder™. **\$399.95**

**37709-09** Reaper. **\$399.95**

**40410-09** Fang. **\$399.95**

**37833-10** Stinger. **\$399.95**

**42200001** Cut Back Gloss Black. **\$149.95**

Fits '04-'06 Touring models. Requires separate purchase of model-specific sprocket mounting hardware.

**40435-04** Chrome ThunderStar. **\$399.95**

Fits '00-'06 Softail® models (except '06 FXST, FXSTB, FXSTS and FLSTFSE). FXSTD models require Spacer Kit P/N 29786-01. Requires separate purchase of model-specific sprocket mounting hardware.

**40447-01** Slotted 6-Spoke. **\$399.95**

**40455-02** Detonator®. **\$399.95**

**40126-00** Chrome ThunderStar. **\$399.95**

**40474-03** Road Winder. **\$399.95**

**46624-03** Mirror Chrome Disc. **\$399.95**

Fits '06 FXST, FXSTB and FXSTS models. Requires separate purchase of model-specific sprocket mounting hardware.

**40698-06** Road Winder. **\$399.95**

Fits '07-'11 FXST, FXSTB, FXSTC, FLSTF, FLSTFB and FLSTSB models (except Japan models). Fits '07-later FXST, FXSTB, FLSTF and FLSTFB models for Asia-Pacific and Brazil. Requires separate purchase of model-specific sprocket mounting hardware.

**37793-07** Road Winder. **\$399.95**

**40134-07** Revolver. **\$399.95**

**37785-07** Blade. **\$399.95**

**40445-08** Reaper. **\$399.95**

**37834-10** Stinger. **\$399.95**

Fits '07-later FXS, FXCW/C, FXSTD, FLSTC, FLSTN, FLSTSC, and '12 FLSTF/B models (except Asia-Pacific and Brazil). Does not fit Japan models. Requires separate purchase of model-specific sprocket mounting hardware.

**40447-07** Slotted 6-Spoke. **\$399.95**

**40126-07** Chrome ThunderStar. **\$399.95**

**40474-07** Road Winder. **\$399.95**

**37800-08** Blade. **\$399.95**

**40228-07** Mirror Chrome Disc. **\$399.95**

**42200004** Cut Back Gloss Black. **\$149.95**

**42200029** Revolver. **\$399.95**

**42200030** Stinger. **\$399.95**

**42200031** Reaper. **\$399.95**

**E. BILLET SPROCKETS**

Notice: The prices appearing in this catalog are the manufacturer's suggested retail prices. Actual retail prices may vary.

# 694 WHEELS

## Brake Rotors

### A. FLOATING BRAKE ROTORS

Complete the custom look with floating brake rotors, styled to complement Original Equipment or custom wheels. Floating rotors feature a steel inner carrier that is shaped to accent the wheel, with a polished and drilled stainless steel outer disc that is precision-riveted in place. Rotors are sold individually, and include chrome installation hardware.

#### Front

Fits '00-later XL, XR and Softail® (except Springer®), '00-'07 Touring models and '00-'05 Dyna® models.

<b>42155-07A</b>	Blade. Left Side.	<b>\$199.95</b>
<b>42156-07A</b>	Blade. Right Side.	<b>\$199.95</b>
<b>44360-00A</b>	Chrome.	<b>\$139.95</b>
<b>44821-00A</b>	Classic Chrome.	<b>\$139.95</b>
<b>44856-02A</b>	Detonator®.	<b>\$154.95</b>
<b>44411-09A</b>	Reaper. Left Side.	<b>\$189.95</b>
<b>46640-07A</b>	Revolver.	<b>\$189.95</b>
<b>44700-03A</b>	Road Winder™. Left Side.	<b>\$189.95</b>
<b>44703-03A</b>	Road Winder. Right Side.	<b>\$189.95</b>
<b>45118-06A</b>	Slotted 6-Spoke.	<b>\$189.95</b>
<b>44367-00A</b>	Teardrop.	<b>\$139.95</b>
<b>44365-00A</b>	ThunderStar™.	<b>\$154.95</b>
<b>44358-00A</b>	Vivid Black.	<b>\$139.95</b>

#### Front

Fits all '84-'99 models. Front rotors must be installed with Brake Pad Kit P/N 44063-83C (sold separately).

<b>44101-95A</b>	Chrome.	<b>\$139.95</b>
<b>44100-95A</b>	Vivid Black.	<b>\$139.95</b>

#### Front

Fits '08-later FXDF and '06-later Dyna models with laced front wheels and Slotted 6-Spoke 19" front wheels.

<b>46778-09A</b>	Classic Black.	<b>\$139.95</b>
------------------	----------------	-----------------

#### Front

Fits '08-later Touring models (except FLHRSE4, FLTRSE3, FLHXSE/2 and Trike). Does not fit with 18" Blade, 18" Road Winder, 18" Reaper, Agitator or Anarchy wheels. Also fits '08-later FXDF and '06-later Dyna models with laced front wheels or Slotted 6-Spoke 19" front wheels.

<b>44944-08A</b>	Chrome.	<b>\$139.95</b>
<b>44942-08A</b>	Teardrop – Chrome & Raw.	<b>\$139.95</b>
<b>41500047</b>	Teardrop – Black & Polished.	<b>\$189.95</b>
<b>44940-08A</b>	ThunderStar.	<b>\$154.95</b>
<b>44947-08A</b>	Vivid Black.	<b>\$139.95</b>

#### Rear

Fits '87-'99 XL and Dyna models, '87-'94 FXR and '99 FXR2 and FXR3, and '87-'99 Softail models. Rear rotors must be installed with Brake Pad Kit P/N 44209-87C (sold separately).

<b>44108-95A</b>	Chrome.	<b>\$139.95</b>
<b>44102-95A</b>	Vivid Black.	<b>\$139.95</b>

#### Rear

Fits '00-later Dyna and Softail models, '00-'10 XL models, and '00-'07 Touring models. Separate purchase of Brake Rotor Hub Plate P/N 43837-00 is required when installing on FXSTD Original Equipment 17" wheels.

<b>42158-07A</b>	Blade.	<b>\$199.95</b>
<b>44359-00A</b>	Chrome.	<b>\$139.95</b>
<b>46777-09A</b>	Classic Black.	<b>\$139.95</b>
<b>44822-00A</b>	Classic Chrome.	<b>\$139.95</b>
<b>44857-02A</b>	Detonator.	<b>\$154.95</b>
<b>44421-09A</b>	Reaper. Right Side.	<b>\$189.95</b>
<b>46641-07A</b>	Revolver.	<b>\$189.95</b>
<b>44706-03A</b>	Road Winder. Right Side.	<b>\$189.95</b>
<b>45047-06A</b>	Slotted 6-Spoke.	<b>\$189.95</b>
<b>44368-00A</b>	Teardrop.	<b>\$139.95</b>
<b>44366-00A</b>	ThunderStar.	<b>\$154.95</b>
<b>44357-00A</b>	Vivid Black.	<b>\$139.95</b>

A

NEW



Blade

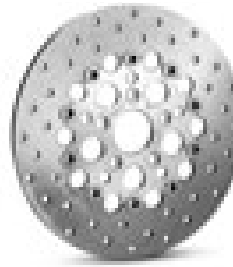

Chrome

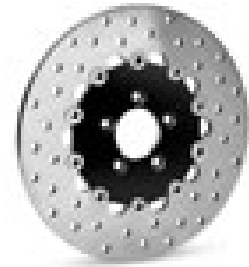

Classic Black

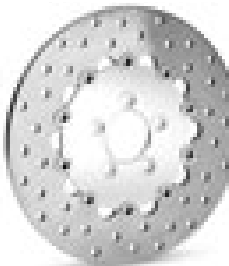

Classic Chrome

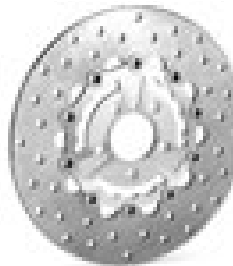

Detonator



Reaper



Revolver

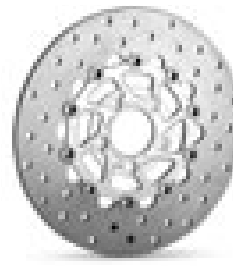

Road Winder



Slotted 6-Spoke

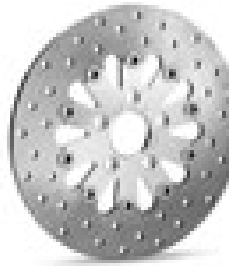

Teardrop

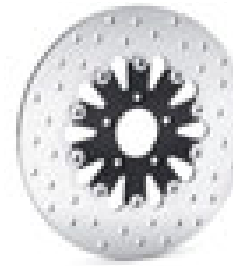

Teardrop – Black

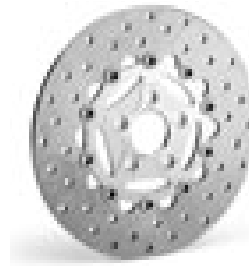

ThunderStar

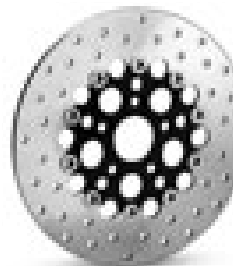

Vivid Black

### A. FLOATING BRAKE ROTORS

Notice: The prices appearing in this catalog are the manufacturer's suggested retail prices. Actual retail prices may vary.



**B**

**B. STINGER FLOATING BRAKE ROTOR**

**B. STINGER CUSTOM FLOATING BRAKE ROTORS**

Both front and rear rotors come complete with new mounting hardware.

<b>48993-10</b>	Front Left. Fits '00-later Softail® models.	<b>\$189.95</b>
<b>48977-10</b>	Front Left. Fits '06-later Dyna® models with barrel-shaped wheel hub.	<b>\$189.95</b>
<b>48978-10</b>	Front Right. Fits '06-later Dyna models with dual disc brakes and barrel-shaped wheel hub.	<b>\$189.95</b>
<b>48979-10</b>	Rear. Fits '00-later Dyna and Softail models.	<b>\$189.95</b>

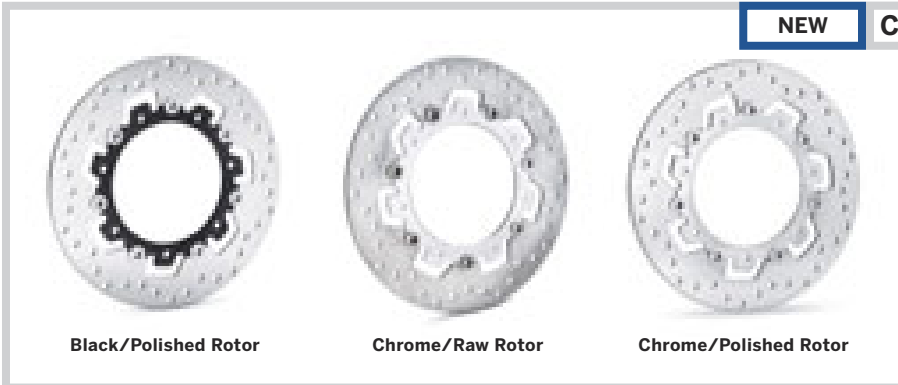

**NEW**

**C**

**C. AGITATOR FLOATING BRAKE ROTORS**

**C. AGITATOR FLOATING BRAKE ROTORS**

Rotors are available in 4 different finishes to match your customizing direction. Chrome rotors include chrome mounting hardware.

Fits '09-later Touring models (except Trike) equipped with Agitator Custom Front Wheel.

**Chrome Inner Spider with Polished Outer Rotor**

<b>41500007</b>	Front Left.	<b>\$189.95</b>
<b>41500008</b>	Front Right.	<b>\$189.95</b>

**Gloss Black Inner Spider with Polished Outer Rotor**

<b>41500052</b>	Front Right.	<b>\$189.95</b>
<b>41500053</b>	Front Left.	<b>\$189.95</b>

**Chrome Inner Spider with Raw Stainless Outer Rotor (stock on '11 CVO™ Street Glide®)**

<b>41500002</b>	Front Left.	<b>\$159.95</b>
<b>41500004</b>	Front Right.	<b>\$159.95</b>

**Raw Inner Spider with Raw Stainless Outer Rotor (stock on '10 CVO Street Glide)**

<b>48981-10</b>	Front Right.	<b>\$149.95</b>
<b>49000-10</b>	Front Left.	<b>\$149.95</b>

**D. POLISHED BRAKE ROTORS**

A perfect complement to stock or custom wheels. Manufactured to Original Equipment specifications for exact fit, these rotors are meticulously polished to achieve a chrome-like appearance. Rotors are sold individually and include chrome installation hardware.

Fits '00-later XL, XR and Softail (except Springer®), '00-'07 Touring models and '00-'05 Dyna models.

<b>41830-05A</b>	Front, Left Side.	<b>\$149.95</b>
<b>41831-05A</b>	Front, Right Side.	<b>\$149.95</b>

Fits '08-later Touring and Trike models (except FLHRSE4, FLTRSE3, FLHXSE/2). Does not fit with 18" Blade, 18" Road Winder™, 18" Reaper, Agitator or Anarchy wheels.

<b>44950-08</b>	Front, Left Side.	<b>\$149.95</b>
<b>44959-08</b>	Front, Right Side.	<b>\$149.95</b>

Fits '08-later Touring models with 18" Blade, 18" Road Winder, 18" Reaper or 18" Anarchy wheels. Fits Trike with 18" Anarchy wheel. Fits '06-later Dyna models (except FXDF and FXDFSE/2) with stock cast wheels or accessory 19" wheels (except Slotted 6-Spoke 19" front wheel), and fits '06-later VRSC™ models with stock cast wheels or accessory 19" front wheels.

<b>41500012A</b>	Front.	<b>\$149.95</b>
------------------	--------	-----------------

Fits '10-later XR and '11-later XL models.

<b>41500005</b>	Rear.	<b>\$149.95</b>
-----------------	-------	-----------------

Fits '00-later Dyna and Softail models, '00-'10 XL models, and '00-'07 Touring models. Separate purchase of Brake Rotor Hub Plate P/N 43837-00 is required when installing on FXSTD Original Equipment 17" wheels.

<b>41832-05A</b>	Rear.	<b>\$149.95</b>
------------------	-------	-----------------



**D**

**D. POLISHED BRAKE ROTOR – FRONT AND REAR**



**D**

**D. POLISHED BRAKE ROTOR – FRONT ('08-LATER TOURING)**

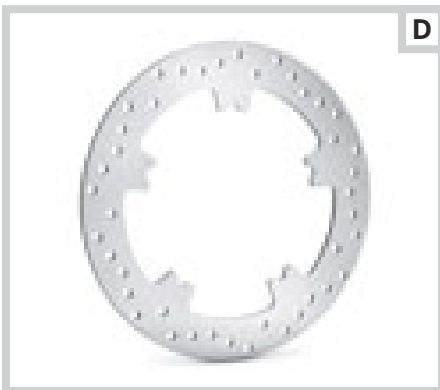

**D**

**D. POLISHED BRAKE ROTOR – FRONT**



**D**

**D. POLISHED BRAKE ROTOR – REAR ('11-LATER XL)**

Notice: The prices appearing in this catalog are the manufacturer's suggested retail prices. Actual retail prices may vary.

# 696 WHEELS

Wheel Accessories

## A. BRAKE ROTOR HARDWARE KIT – CHROME

It's the details, like this chrome hardware kit, that really get your bike noticed. This hardware adds a unique chrome-plated finish to the Original Equipment or accessory floating brake rotors. Kit includes 5 chrome-plated bolts manufactured to factory specifications to ensure fit and performance.

**91800029** Shoulder Bolt – Front. **\$29.95**  
Fits '02-later models equipped with Open Brake Rotor P/N 44343-01, 44553-06A, 41500012, 41500040 or 41500042.

**46646-05** Button Head – Front. **\$12.95**  
Fits '90-later models (except models equipped with Open Brake Rotor P/N 44343-01, 44553-06A, 41500012, 41500040 or 41500042).

**46647-05** Button Head – Rear. **\$13.95**  
Fits '92-later models (except Trike).

## B. CHROME HARDWARE KIT FOR REAR BELT SPROCKET – HEX HEAD

This kit includes highly-polished, chrome-plated, grade 8 hex-head screws with chrome-plated washers, providing an extra custom accent. The perfect addition to the chrome sprocket. Made from the same Original Equipment bolts to ensure product integrity. Also works with chrome belt sprocket covers and Original Equipment sprockets.

**94773-07** **\$29.95**  
Fits '07-later Dyna® and Softail® models.

**94773-00A** **\$29.95**  
Fits '00-'06 Softail and '00-'05 Dyna models.

**94708-98** **\$29.95**  
Fits '93-'99 Softail, '93-'99 Dyna and '91-later XL models.



A. CHROME BRAKE ROTOR HARDWARE KIT – SHOULDER BOLT

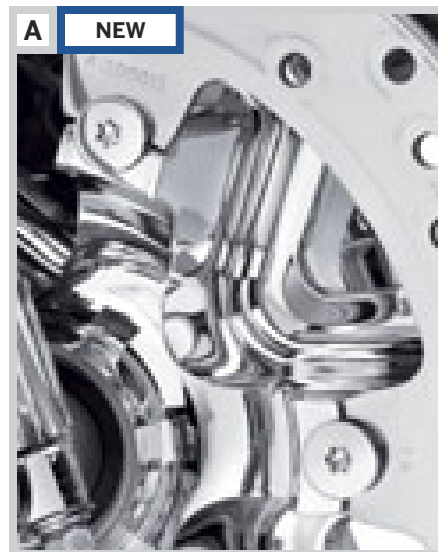

A. CHROME BRAKE ROTOR HARDWARE KIT – BUTTON HEAD



B. CHROME HARDWARE KIT FOR REAR BELT SPROCKET – HEX HEAD



Notice: The prices appearing in this catalog are the manufacturer's suggested retail prices. Actual retail prices may vary.



**C. REAR SPROCKET BOLT COVER KIT**



**C. REAR SPROCKET BOLT COVER KIT**

These chrome-plated covers with internal spring clips hide the Original Equipment sprocket bolts for a clean, custom look. Set of 5 covers.

**43876-04** **\$38.95**

Fits '93-later Softail®, '99-later Touring (except Trike) and '04-later XL models with Original Equipment 7/16" hex head sprocket mounting bolts (5/8" hex across the flats).

**D. DECORATIVE WHEEL WEIGHTS**

Calibrate your wheel balance with a touch of class with these uniquely designed wheel weights. Adhesive backing for easy installation.

**Skull**

Fits Original Equipment and accessory wheel rims.

**95617-04** 1/4 oz. **\$2.00**

**95619-04** 1/2 oz. **\$2.00**

**Bar & Shield Logo**

Fits Original Equipment and accessory wheel rims.

**95613-04** 1/4 oz. **\$2.00**

**95615-04** 1/2 oz. **\$2.00**



**D. DECORATIVE WHEEL WEIGHTS – SKULL**



**D. DECORATIVE WHEEL WEIGHTS – BAR & SHIELD**

**E. CHROME-PLATED ABS VALVE STEM CAPS**

A special chrome touch with special graphics. Will not seize on valve stems and includes O-rings for reliable seal. Sold in pairs.

Universal fitment. Also fits suspension air valves.

**1. 41146-97** Gold "H-D" Logo Outline on Black. **\$8.95**

**2. 41144-97** Color Bar & Shield Logo. **\$8.95**

**3. 41145-97** **\$8.95**

White Bar & Shield Logo Outline on Black.

**4. 41171-03** White Skull Logo on Black. **\$8.95**

**F. CHROME-PLATED BRASS VALVE STEM CAPS**

The beauty of chrome with the durability of machined brass, featuring a laser-etched Bar & Shield logo painted black. Available with a traditional, unique fluted or rugged acorn shaped cylinder. Will not seize on valve stems and includes O-rings for reliable seal. Sold in pairs.

Universal fitment. Also fits suspension air valves.

**1. 41149-98** **\$13.95**

Fluted Cylinder with Bar & Shield Logo.

**2. 41148-98** **\$13.95**

Acorn Nut with Bar & Shield Logo.

**3. 41150-98** **\$13.95**

Acorn Nut with Grooved Cylinder with Bar & Shield Logo.



**E. CHROME-PLATED ABS VALVE STEM CAPS**



**F. CHROME-PLATED BRASS VALVE STEM CAPS**

*Notice: The prices appearing in this catalog are the manufacturer's suggested retail prices. Actual retail prices may vary.*